



Badger Farm Bridge Club - 8 April 2008

<div style="text-align: center; margin-bottom: 10px;"> </div> <div style="display: flex; justify-content: space-between;"> <div style="width: 45%;"> <p>♠ AJ ♥ QT8532 ♦ J874 ♣ T</p> </div> <div style="width: 45%;"> <p>♠ 752 ♥ A4 ♦ Q9532 ♣ 862</p> </div> </div> <p style="text-align: center; font-weight: bold; margin: 10px 0;">Hand 1</p> <div style="display: flex; justify-content: space-between;"> <div style="width: 45%;"> <p>♠ KQT86 ♥ K97 ♦ A6 ♣ A97</p> </div> <div style="width: 45%;"> <p>♠ 943 ♥ J6 ♦ KT ♣ KQJ543</p> </div> </div>	<div style="text-align: center; margin-bottom: 10px;"> </div> <div style="display: flex; justify-content: space-between;"> <div style="width: 45%;"> <p>♠ 98763 ♥ J8 ♦ J76 ♣ T62</p> </div> <div style="width: 45%;"> <p>♠ KQT ♥ AT96 ♦ AT9 ♣ J74</p> </div> </div> <p style="text-align: center; font-weight: bold; margin: 10px 0;">Hand 2</p> <div style="display: flex; justify-content: space-between;"> <div style="width: 45%;"> <p>♠ 4 ♥ Q32 ♦ KQ8543 ♣ A83</p> </div> <div style="width: 45%;"> <p>♠ AJ52 ♥ K754 ♦ 2 ♣ KQ95</p> </div> </div>	<div style="text-align: center; margin-bottom: 10px;"> </div> <div style="display: flex; justify-content: space-between;"> <div style="width: 45%;"> <p>♠ Q5 ♥ K96 ♦ JT854 ♣ J32</p> </div> <div style="width: 45%;"> <p>♠ 982 ♥ 8754 ♦ K62 ♣ Q76</p> </div> </div> <p style="text-align: center; font-weight: bold; margin: 10px 0;">Hand 3</p> <div style="display: flex; justify-content: space-between;"> <div style="width: 45%;"> <p>♠ AT7643 ♥ J32 ♦ Q7 ♣ K9</p> </div> <div style="width: 45%;"> <p>♠ KJ ♥ AQT ♦ A93 ♣ AT854</p> </div> </div>
<div style="text-align: center; margin-bottom: 10px;"> </div> <div style="display: flex; justify-content: space-between;"> <div style="width: 45%;"> <p>♠ QT64 ♥ K832 ♦ KJT4 ♣ 4</p> </div> <div style="width: 45%;"> <p>♠ K972 ♥ T75 ♦ 5 ♣ QT963</p> </div> </div> <p style="text-align: center; font-weight: bold; margin: 10px 0;">Hand 4</p> <div style="display: flex; justify-content: space-between;"> <div style="width: 45%;"> <p>♠ AJ85 ♥ A9 ♦ 632 ♣ AKJ7</p> </div> <div style="width: 45%;"> <p>♠ 3 ♥ QJ64 ♦ AQ987 ♣ 852</p> </div> </div>	<div style="text-align: center; margin-bottom: 10px;"> </div> <div style="display: flex; justify-content: space-between;"> <div style="width: 45%;"> <p>♠ KJ95 ♥ KQT84 ♦ ♣ Q653</p> </div> <div style="width: 45%;"> <p>♠ AT ♥ 7532 ♦ QJ42 ♣ KJ4</p> </div> </div> <p style="text-align: center; font-weight: bold; margin: 10px 0;">Hand 5</p> <div style="display: flex; justify-content: space-between;"> <div style="width: 45%;"> <p>♠ 843 ♥ AJ6 ♦ 98765 ♣ 87</p> </div> <div style="width: 45%;"> <p>♠ Q762 ♥ 9 ♦ AKT3 ♣ AT92</p> </div> </div>	<div style="text-align: center; margin-bottom: 10px;"> </div> <div style="display: flex; justify-content: space-between;"> <div style="width: 45%;"> <p>♠ QJT62 ♥ K6 ♦ 95 ♣ 9654</p> </div> <div style="width: 45%;"> <p>♠ K93 ♥ A98753 ♦ 4 ♣ K83</p> </div> </div> <p style="text-align: center; font-weight: bold; margin: 10px 0;">Hand 6</p> <div style="display: flex; justify-content: space-between;"> <div style="width: 45%;"> <p>♠ A854 ♥ T4 ♦ T872 ♣ QJT</p> </div> <div style="width: 45%;"> <p>♠ 7 ♥ QJ2 ♦ AKQJ63 ♣ A72</p> </div> </div>
<div style="text-align: center; margin-bottom: 10px;"> </div> <div style="display: flex; justify-content: space-between;"> <div style="width: 45%;"> <p>♠ KT83 ♥ Q62 ♦ J ♣ QT953</p> </div> <div style="width: 45%;"> <p>♠ QJ5 ♥ AT987 ♦ 964 ♣ J6</p> </div> </div> <p style="text-align: center; font-weight: bold; margin: 10px 0;">Hand 7</p> <div style="display: flex; justify-content: space-between;"> <div style="width: 45%;"> <p>♠ A964 ♥ K ♦ A752 ♣ A872</p> </div> <div style="width: 45%;"> <p>♠ 72 ♥ J543 ♦ KQT83 ♣ K4</p> </div> </div>	<div style="text-align: center; margin-bottom: 10px;"> </div> <div style="display: flex; justify-content: space-between;"> <div style="width: 45%;"> <p>♠ AK3 ♥ Q842 ♦ T853 ♣ Q9</p> </div> <div style="width: 45%;"> <p>♠ Q7 ♥ K3 ♦ KQ74 ♣ KJT82</p> </div> </div> <p style="text-align: center; font-weight: bold; margin: 10px 0;">Hand 8</p> <div style="display: flex; justify-content: space-between;"> <div style="width: 45%;"> <p>♠ T92 ♥ T976 ♦ AJ9 ♣ 765</p> </div> <div style="width: 45%;"> <p>♠ J8654 ♥ AJ5 ♦ 62 ♣ A43</p> </div> </div>	<div style="text-align: center; margin-bottom: 10px;"> </div> <div style="display: flex; justify-content: space-between;"> <div style="width: 45%;"> <p>♠ J7 ♥ KQJ9863 ♦ 8 ♣ K72</p> </div> <div style="width: 45%;"> <p>♠ AQT94 ♥ T5 ♦ Q4 ♣ J653</p> </div> </div> <p style="text-align: center; font-weight: bold; margin: 10px 0;">Hand 9</p> <div style="display: flex; justify-content: space-between;"> <div style="width: 45%;"> <p>♠ K62 ♥ 742 ♦ T963 ♣ A98</p> </div> <div style="width: 45%;"> <p>♠ 853 ♥ A ♦ AKJ752 ♣ QT4</p> </div> </div>
<div style="text-align: center; margin-bottom: 10px;"> </div> <div style="display: flex; justify-content: space-between;"> <div style="width: 45%;"> <p>♠ 53 ♥ A9742 ♦ 62 ♣ AQ96</p> </div> <div style="width: 45%;"> <p>♠ AKT6 ♥ Q8 ♦ QT4 ♣ KJT5</p> </div> </div> <p style="text-align: center; font-weight: bold; margin: 10px 0;">Hand 10</p> <div style="display: flex; justify-content: space-between;"> <div style="width: 45%;"> <p>♠ J72 ♥ KT65 ♦ KJ75 ♣ 32</p> </div> <div style="width: 45%;"> <p>♠ Q984 ♥ J3 ♦ A983 ♣ 874</p> </div> </div>	<div style="text-align: center; margin-bottom: 10px;"> </div> <div style="display: flex; justify-content: space-between;"> <div style="width: 45%;"> <p>♠ KJ52 ♥ 64 ♦ KJ9 ♣ KJ43</p> </div> <div style="width: 45%;"> <p>♠ A983 ♥ AKJT3 ♦ 8654 ♣</p> </div> </div> <p style="text-align: center; font-weight: bold; margin: 10px 0;">Hand 11</p> <div style="display: flex; justify-content: space-between;"> <div style="width: 45%;"> <p>♠ QT74 ♥ 985 ♦ AT ♣ 9872</p> </div> <div style="width: 45%;"> <p>♠ 6 ♥ Q72 ♦ Q732 ♣ AQT65</p> </div> </div>	<div style="text-align: center; margin-bottom: 10px;"> </div> <div style="display: flex; justify-content: space-between;"> <div style="width: 45%;"> <p>♠ 3 ♥ KT875 ♦ KQ4 ♣ K975</p> </div> <div style="width: 45%;"> <p>♠ KT4 ♥ 62 ♦ A972 ♣ AQJ6</p> </div> </div> <p style="text-align: center; font-weight: bold; margin: 10px 0;">Hand 12</p> <div style="display: flex; justify-content: space-between;"> <div style="width: 45%;"> <p>♠ Q52 ♥ Q4 ♦ J8653 ♣ 832</p> </div> <div style="width: 45%;"> <p>♠ AJ9876 ♥ AJ93 ♦ T ♣ T4</p> </div> </div>



 JT52
 Q7
 A874
 J96



 63
 AK
 J632
 KT732

Hand 13

A87
 J9863
 QT
 AQ5

KQ94
 T542
 K95
 84



 AKJ
 T83
 AT82
 KQ6

QT53
 76542
 5
 T92

Hand 14

7
 AK9
 QJ64
 AJ853

98642
 QJ
 K973
 74



 Q2
 QT4
 AK5
 AKJT8

K8764
 AJ9
 J862
 Q

Hand 15

A9
 863
 QT9743
 75

JT53
 K752
 96432



 84
 AQ4
 64
 AJ7643

AKT65
 7532
 J952

Hand 16

72
 J8
 A73
 KQ9852

QJ93
 KT96
 KQT8
 T



 KJ95
 KJ96
 5
 JT62

Q762
 AT2
 AQT62
 4

Hand 17

A3
 83
 943
 AK9853

T84
 Q754
 KJ87
 Q7



 73
 AT8
 J8
 QJ8765

K8542
 K6432
 K2
 3

Hand 18

QJ6
 QJ9
 T976
 KT9

AT9
 75
 AQ543
 A42



 KT94
 J52
 K7
 KQ83

A
 97643
 AQJT93
 2

Hand 19

8752
 AT
 842
 JT95

QJ63
 KQ8
 65
 A764



 KJ82
 75
 AK92
 A96

T43
 J32
 J874
 QT3

Hand 20

AQ76
 KQT8
 Q
 K754

95
 A964
 T653
 J82



 T
 K973
 QT8
 AQJT8

Q94
 AJT52
 AJ32
 4

Hand 21

AK863
 8
 K964
 963

J752
 Q64
 75
 K752



 AQ82
 A4
 K85
 AT43

KJ97
 KQ8
 J3
 K972

Hand 22

T54
 T765
 T4
 QJ85

63
 J932
 AQ9762
 6



 KQJ754
 Q863
 A
 AK

932
 KT974
 T8
 Q65

Hand 23

AT8
 5
 QJ7652
 J84

6
 AJ2
 K943
 T9732



















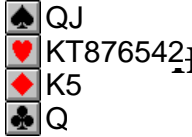





 5
 J654
 T52
 KJ975

AKJ94
 T
 K9
 AQ632

Hand 24

T762
 Q3
 AQJ843
 4

Q83
 AK9872
 76
 T8

<div style="display: flex; justify-content: space-between;"> <div style="text-align: center;">  </div> <div style="text-align: center;">  </div> </div> <div style="display: flex; justify-content: space-around; margin-top: 20px;"> <div style="text-align: center;">  </div> <div style="text-align: center;"> <p>Hand 25</p>  </div> </div> <div style="display: flex; justify-content: center; margin-top: 20px;">  </div>	<div style="display: flex; justify-content: space-between;"> <div style="text-align: center;">  </div> <div style="text-align: center;">  </div> </div> <div style="display: flex; justify-content: space-around; margin-top: 20px;"> <div style="text-align: center;">  </div> <div style="text-align: center;"> <p>Hand 26</p>  </div> </div> <div style="display: flex; justify-content: center; margin-top: 20px;">  </div>	<div style="display: flex; justify-content: space-between;"> <div style="text-align: center;">  </div> <div style="text-align: center;">  </div> </div> <div style="display: flex; justify-content: space-around; margin-top: 20px;"> <div style="text-align: center;">  </div> <div style="text-align: center;"> <p>Hand 27</p>  </div> </div> <div style="display: flex; justify-content: center; margin-top: 20px;">  </div>
<div style="text-align: center;">  </div>	<div style="text-align: center;">  </div>	<div style="text-align: center;">  </div>
<div style="text-align: center;">  </div>	<div style="text-align: center;">  </div>	<div style="text-align: center;">  </div>
<div style="text-align: center;">  </div>	<div style="text-align: center;">  </div>	<div style="text-align: center;">  </div>

Hand Pattern	% This Deal	# This Deal	% Theory
4-4-3-2	24.07	26	21.55
5-3-3-2	14.81	16	15.52
5-4-3-1	13.89	15	12.93
5-4-2-2	6.48	7	10.58
4-3-3-3	7.41	8	10.54
6-3-2-2	8.33	9	5.64
6-4-2-1	4.63	5	4.70
6-3-3-1	5.56	6	3.45
5-5-2-1	1.85	2	3.17
4-4-4-1	6.48	7	2.99
7-3-2-1	0.93	1	1.88
6-4-3-0	0.00	0	1.33
5-4-4-0	3.70	4	1.24
5-5-3-0	0.00	0	0.90
6-5-1-1	0.93	1	0.71
6-5-2-0	0.00	0	0.65
7-2-2-2	0.00	0	0.51
7-4-1-1	0.00	0	0.39
7-4-2-0	0.00	0	0.36
7-3-3-0	0.00	0	0.27
Other	0.93	1	0.69

HPC/Seat: N - 283 (26.20); S - 275 (25.46); E - 255 (23.61); W - 267 (24.72)

Number of suits over 6 cards (Theory - 4.4): N - 1; S - 0; E - 0; W - 1

Number of suits with void (Theory - 5.5): N - 1; S - 1; E - 0; W - 2

Number of suits with singleton (Theory - 33.0): N - 9; S - 11; E - 8; W - 11